

# News<sup>2017</sup>

# 新产品<sup>2017</sup>

The world's biggest  
timepiece event



 HKTC  
Hong Kong Watch & Clock Fair  
5-9 September 2017  
Hong Kong convention and Exhibition Centre

  
**BERGEON**  
Depuis 1791

# B-SETTING4

SWISS MADE

8935



## Setting tool with 4 runners for hands

Interchangeable stakes made of synthetic material.  
Base:  $\varnothing$  31 mm. Enhanced guidance of the spindles.  
High precision of positioning.

*The "Limite Force" Runner, which fits with our 8935 setting tools, enables the user to limit the output force on hands through a gear system. This force can be regulated with a screwdriver, from 5N to 40N with a precision of  $\pm 15\%$ .*

“限制力度”装针轴，可配合我们的8935装针机使用。通过齿轮系统限制力度。该力度可用一把螺丝刀来调整，5N到40N的力度，精度为 $\pm 15\%$ 。

8935-LF



## 四针装针机

人造材料制压头及不锈钢制装针轴。 $\varnothing$  31 mm底座。强化针轴套筒。高精度中轴线。

7100-...

swiss made

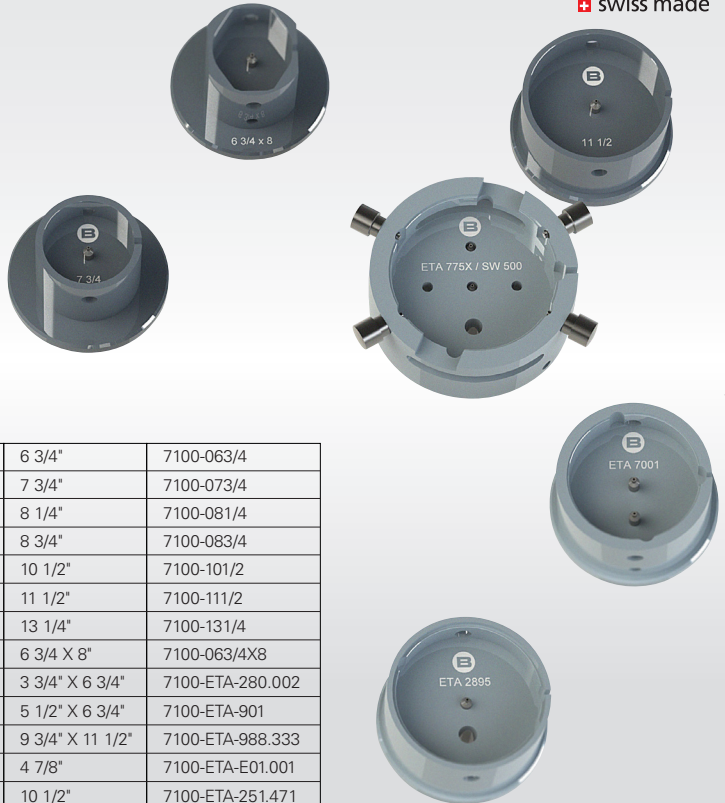

○	6 3/4"	7100-063/4
○	7 3/4"	7100-073/4
○	8 1/4"	7100-081/4
○	8 3/4"	7100-083/4
○	10 1/2"	7100-101/2
○	11 1/2"	7100-111/2
○	13 1/4"	7100-131/4
◎	6 3/4 X 8"	7100-063/4X8
ETA 280.002	3 3/4" X 6 3/4"	7100-ETA-280.002
ETA 901-980.153/163	5 1/2" X 6 3/4"	7100-ETA-901
ETA 988.333	9 3/4" X 11 1/2"	7100-ETA-988.333
ETA E01.001	4 7/8"	7100-ETA-E01.001
ETA 251.471 Chrono	10 1/2"	7100-ETA-251.471
ETA 2094	10 1/2"	7100-ETA-2094
ETA G15.211 Chrono	10 1/2"	7100-ETA-G15.211
ETA 7001	10 1/2"	7100-ETA-7001
ETA 2895 Petite seconde	11 1/2"	7100-ETA-2895
ETA 2894-2 Chronographe	12 1/2"	7100-ETA-2894-2
ETA 251.2XX	13 1/4"	7100-ETA-251.2XX
775X / SW500	13 1/4"	7100-ETA-775X
ETA G10.211	13 1/4"	7100-ETA-G10.211
ETA 6497/8	16 1/2"	7100-ETA-6497
ETA A07.211 et A07.213	16 1/2"	7100-ETA-A07.211

## Movement holder for hand setting

Execution in anodized aluminum, hardened / tempered steel bearing screw with polished tip and locking system.

## 装针用机芯座

镀铝，硬化钢轴承螺丝，抛光顶尖，锁定系统

**7965-S12**

swiss made

Ø 0.60 / 0.70 / 0.80 / 0.90 / 1.00 / 1.20 / 1.40 / 1.50 / 1.60 / 1.80 / 2.00 / 2.50



**Turning stand with 12 watchmaker screwdrivers with special profile**

With 6 emplacements to fit dynamometric cylinders 7965-C and a removable container for spare blades.

**修表匠专用螺丝刀，12支装配可旋转台座。**

带有6个卡位用于放置力矩环7965-C，以及一个用于放置备用刀头的可移动胶筒。



7965-C...

swiss made



**TORK  
 SPEED**  
 SWISS MADE  
 PATENT PENDING

10 - 15 - 20 - 25 - 30 - 35 - 40 - 45 - 50 - 55 - 60 mNm



### Demountable dynamometric cylinder

Stainless steel. Fit on all specific screwdrivers with reference 7965-...

Pre-set, fixed torque: 10 to 60 mNm.

Bidirectional cylinder. Can be easily positioned on the whole length of the handle of the screwdriver.

Possibility to equip the screwdriver with 2 cylinders.

### 可拆卸的力矩环

不锈钢制成。适用于 所有特定的螺丝刀，请参阅编号7965-...

预先设定的固定扭矩：10~60mNm。

双向环，可以很容易地定位在螺丝刀的手柄的整个长度。一支螺丝刀能同时装上两个力矩环。

7895-M-010-... 10x

7895-T-...

Plastic tube with 2 blades  
 胶筒装两支刀玉



swiss made

∅ 0.50 - 0.60 - 0.70 - 0.80 - 0.90 - 1.00 - 1.10 - 1.20 - 1.30 - 1.40 - 1.50 - 1.60 - 2.00 - 2.20 - 2.50 - 3.00 mm

### Blades with parallel-flanks

Steel HSS 61 HRC.

### 平衡刀玉

高速钢 61 HRC

## 30081-P05

Ø 0.80 / 1.00 / 1.20 / 1.40 / 1.60

swiss made



### Pouch with 5 screwdrivers 30081

Ergonomic Screwdriver of stainless steel with head of synthetic self-lubricating POM material and conical blades of hardened stainless steel 54/56HRC.

### 袋装5支螺丝刀30081

符合人体工学的不锈钢螺丝刀。头部是用带有自润滑合成材料POM制作而成，圆锥形螺丝刀玉材质是加硬的不锈钢54/56HRC。

## 6899-P05

Ø 0.80 / 1.00 / 1.20 / 1.40 / 1.60

swiss made



### Pouch with 5 screwdrivers 6899

Ergonomic Screwdriver of stainless steel and elastomer coat with head of synthetic self-lubricating POM material and blades of hardened stainless steel 54/56HRC.

### 袋装5支螺丝刀6899

符合人体工学的不锈钢螺丝刀。刀身包有人造橡胶。头部是用带有自润滑合成材料POM制作而成，螺丝刀玉材质是加硬的不锈钢54/56HRC。

**5659**

swiss made

∅ 1.50 / 2.00 / 2.50 / 3.00

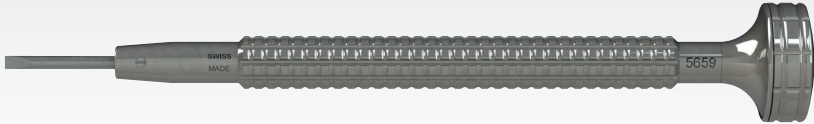

### Screwdriver with ball bearing head

Shank made of stainless steel with grooved profile.  
Conical blade made of hardened stainless steel  
54/56HRC reference 6899-M. ∅ of head: 18 mm. ∅  
of shank: 8 mm. Total length: 105 mm.

### 带滚珠转动头部的螺丝刀

带有特殊滚花的不锈钢螺丝刀身。锥形刀玉材质为加硬不锈钢54/56HRC，产品编号6899-M。顶部直径：18mm。刀身直径：8mm。总长度：105mm。

**30081-TAM-...**

swiss made

∅ 1.00 / 1.20 / 1.30 / 1.40 / 1.60 / 1.80

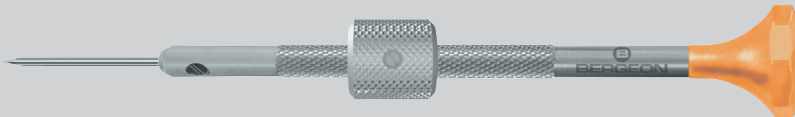

### Sets of 2 drums

Shank in knurled stainless steel.  
Self-lubricating head, synthetic POM material.  
Conical blade made of hardened stainless steel  
54/56HRC reference 6899-M.  
The drum allows increased screwing force.

### 带有鼓轮的螺丝刀

滚花不锈钢刀身。头部是用带有自润滑合成材料POM制作而成。锥形刀玉材质为加硬不锈钢54/56HRC，产品编号6899-M。  
鼓轮可用于增加拧紧螺丝的力度。

## 30081-C-P05

Ø 1.20 / 1.50 / 2.00 / 2.50 / 3.00

swiss made

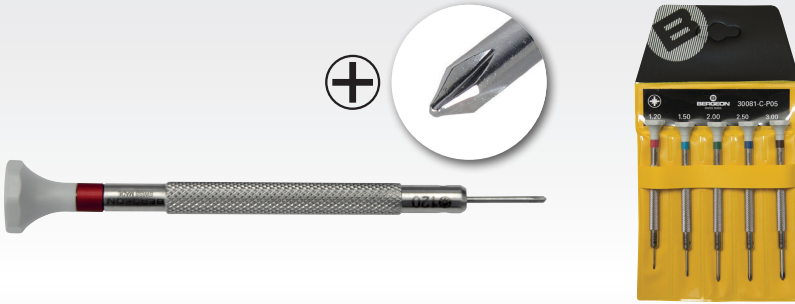

### Pouch with 5 screwdrivers with Phillips blades

Ergonomic Screwdriver of stainless steel with head of synthetic self-lubricating POM material and "Phillips" blades of hardened stainless steel 53/55HRC.

### 袋装5支“十”字头型螺丝刀

符合人体工学的不锈钢螺丝刀。顶部是用带有自润滑合成材料POM制作而成，圆锥形螺丝刀玉材质是加硬的不锈钢54/56HRC。

## 30081-EX-7750

swiss made

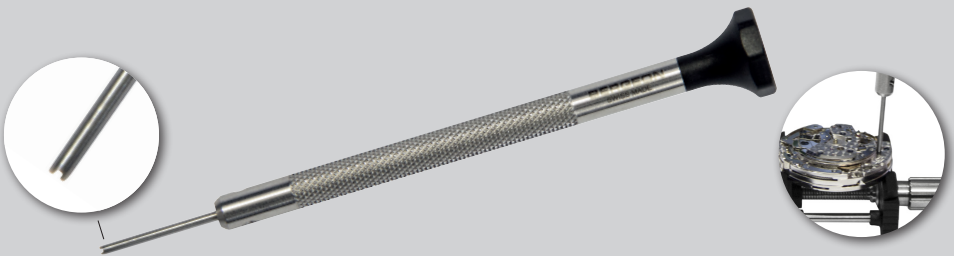

### Tool to adjust the eccentric screw of calibre ETA Valjoux 7750

Screwdriver with adapted blade to adjust the eccentric screw of the minute counter for the calibre range ETA Valjoux 7750.

### 用于调整ETA Valjoux 7750机芯偏心螺丝的工具

带有特制形状刀玉的螺丝刀用于调整ETA Valjoux 7750机芯积分盘上的偏心螺丝。

2611-TN-...

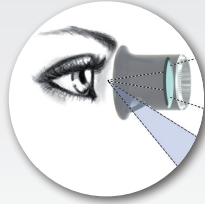

2611-TB-...



✎ 6.7x / 5x / 4x / 3.3x / 2.8x / 2.5x

### Watchmaker's eyeglass

Made of synthetic material with anti-mist and sight opening.

### 修表匠专用的放大镜

由合成材料制成并具有抗雾和视线开口功能。

7913



✎ 1.5x / 2.0x / 2.5x / 3.0x / 3.5x / 4.0x



### Watchmaker Eyeglass with clip for glasses

Removable eyeglass with a protected clip.

### 带眼镜夹的表匠用放大镜

放大镜可移动，带有一个保护夹。

8845

swiss made



**Contenu - 内含**

6745-G: 2x 0.60/0.80/1.00 mm  
6745-GC: 2x 0.60/0.80/1.00 mm



**Press to drive bracelet pins in and out**

Press with holding wheel mounted on threaded shaft to drive bracelet pins without using a hammer.

**安装及拆除表带梢针工具**

配有握轮，不用槌子也可拆除表带梢针

8744

swiss made



### Vice for tightening bracelet

Vice allowing to hold the bracelet in vertical position allowing to operate lengthening bracelets. In synthetic material.

Compatible with press 7745, 8745 & 8845.

### 夹表带座

合成材料制造，可夹紧垂直放置的长表带，配合7745，8745及8845等工具使用



**Contenu - 内含**

- 6745-G: 1x 040/060/080/1.00/1.50/2.00 mm
- 6745-M: 2x 080/1.00/1.20 mm
- 6745-MC: 1x 1.50/2.00 mm

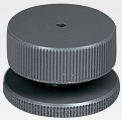
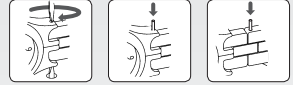

6745-SR28



8745-SRC



**B-PRESS**  
 SWISS MADE

**8745-BD**

*Runner with special flute to fit dynamometric cylinders with the reference 7965-C... Allows the controlled tightening of bracelet screws with a pre-defined torque.*

带特殊凹槽纹（滚花）的顶杆，可配合no. 7965-C 系列力矩环使用。可用预设的力度锁紧表带螺丝。



**8745**

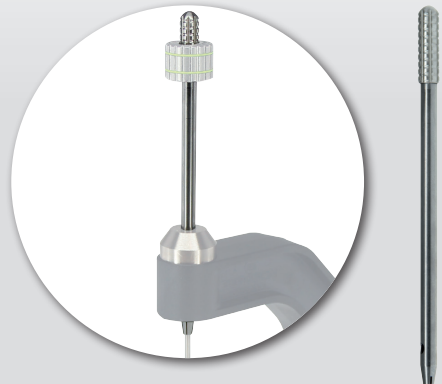

**Multifunction Press**

Made of composite material.  
 To insert and remove pins as well as to screw and unscrew watch bracelets.

**多功能表带装拆工具**

以人工合成材料制造，供安装/拆除金属表带的穿针及螺丝。

8745-BSC

7745-PG

**B-PRESS**

SWISS MADE



**Contenu - 内含**

6745-G: 1x 040/060/080/1.00/1.50/2.00 mm

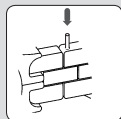
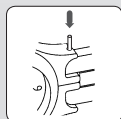
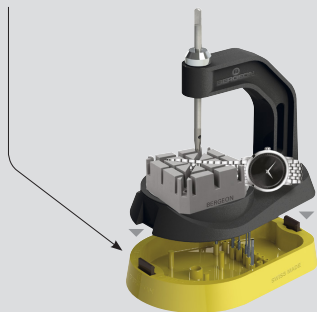

**Press**

Made of composite material.  
To insert and remove pins.

**表带装拆工具**

以人工合成材料制造，供安装/拆除金属表带的穿针。

7819

swiss made



### Device for bowing the folding buckles

Tool allowing to adjust the opening resistance of the folding clasp buckles.

### 用于调整表扣的夹具

可用于调整表扣的开口弧度，来调整表扣松紧。

7956

swiss made

**EASYCUT**

SWISS MADE

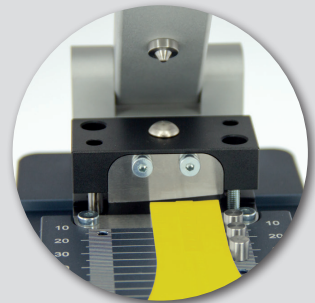
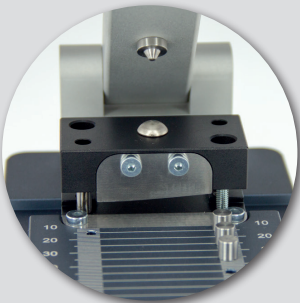
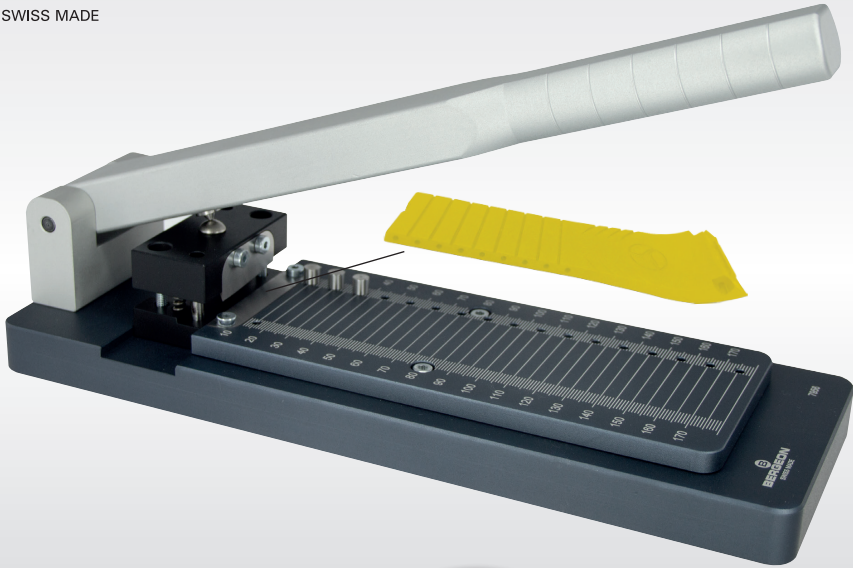

**Tool for cutting the watch straps**

Allows an simple and precise cut to length of leather or rubber watch straps.

**切割手表皮帶工具**

切割皮革或橡膠手表帶。操作简单，切口整齊。

**MASTER SERVICE**  
 SWISS MADE

7815

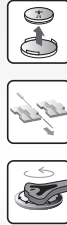

6744-P



2963-B



6x Ø 15 x 30 mm

8745



2819-08

3x  
2819-A



3x  
2819-B

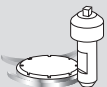

3x  
2819-C

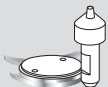

3x  
2819-D



6460-P



7026-1



3153



1282-A



4056-6



2819-08-R

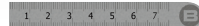

30540



2611-TN-2.5



7039



6789-N



2510-N



4932



6899-T-...



30081-...



Ø 1.00 - 1.20 - 1.40 - 1.60 - 2.00 mm

**Master Service Tool Case**

For the batteries service, bracelets change and length setting. Opening and closing of the screwed back covers. Contains: 46 specialized tools and accessories.

**专业工具箱**

用于换电池，更换表带及调整表带长度。开/关螺丝底盖。

内含：46种精选工具及配件

Tool for fitting and removing  
spring-bars

拆装生耳的工具

**7767-SF**



**7767-S**



**7767-F**



**8111**



**Reversible point  
and spatula-shaped fork**  
Gripping the pins with a chuck.

可更换的尖端以及铲型的叉头  
Sujeción de las puntas por mandril.

30417



### Hammer bi-materials

Hammer one End in synthetic material and the other in brass. The Ends are replaceable.

### 双头锤

一头是合成材料，另一头是黄铜。两个头均可更换。



## 30097-BC

swiss made

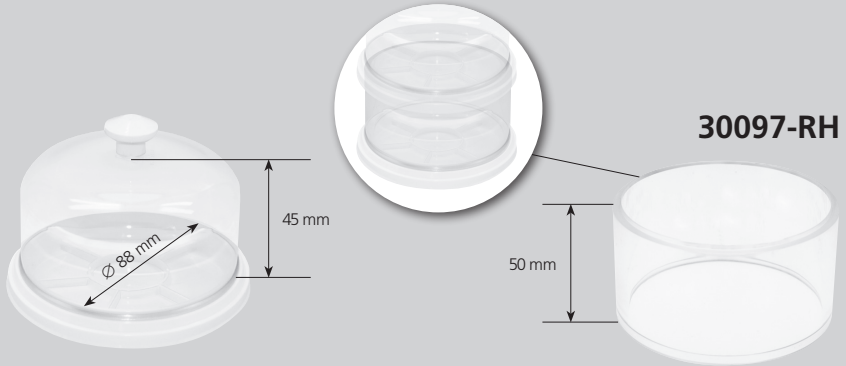

### Cover, tray and extension cover

The extension cover allows to stack several trays directly on one other to save space on the workbench.

### 防尘罩，零件托盘及增高部件

使用增高部件可以在工作台上把几个零件托盘一件摞一件安全地堆高几层。

## 30097-XL-BC

swiss made

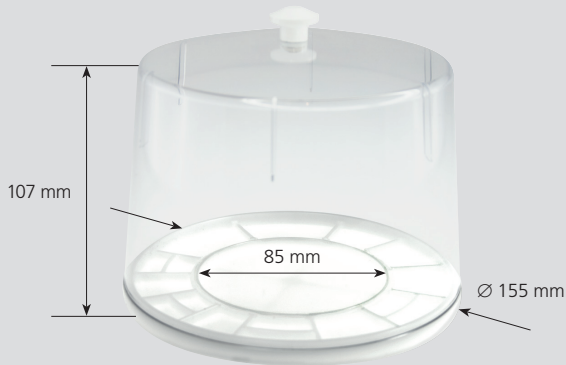

### XL tray and cover

17 trays of various sizes, the central tray can receive cleaning baskets and casing cushions until  $\varnothing 85 \text{ mm}$ .

### 加大码的防尘罩及零件托盘

17个不同尺寸的零件格，托盘中心的间隔可以放置不超过 $\varnothing 85 \text{ mm}$ 的清洁篮及表壳垫。

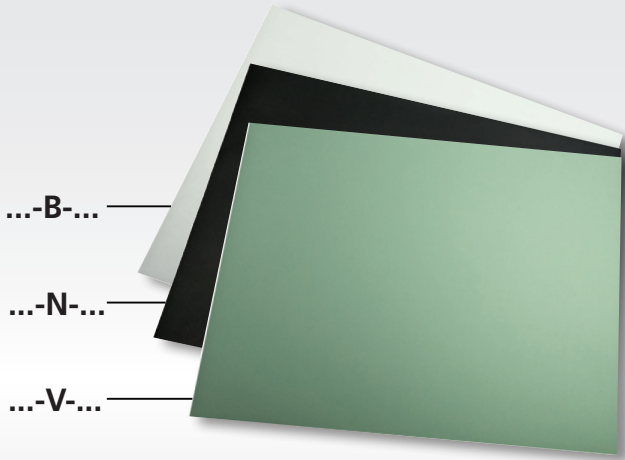

...-01

1 x

...-10

10 x

swiss made

**5808-...** 320 x 240 x 1.5 mm

### Self-adhesive bench mat

Structured, stiff and isopropyl alcohol resistant surface, adhesive undersurface.

### 自粘台垫

表面材质密实，不易弯曲，耐异丙基酒精腐蚀，底部可自粘。

**6808-...** 320 x 240 x 0.6 mm

### Fine self-adhesive bench mat

Flat, stiff and solvent resistant surface, adhesive undersurface.

### 薄款自粘台垫

表面光滑，不易弯曲，耐化学溶剂腐蚀，底部可自粘。

**7808-...** 320 x 240 x 2 mm

### Anti-skid bench mat

Lightly structured, flexible and isopropyl alcohol resistant surface, anti-skid undersurface.

### 防滑台垫

材质柔软有弹性，表面耐异丙基酒精腐蚀，底部特别防滑设计。

## 6173-B

*Micrometric stop for rack press  
Nickel-Steel. Adjustment by micrometric screw.  
Precision: 0.01 mm graduation.*

微调器，用于多用途滚齿式冲压机  
镍钢材质。可用测微螺丝调整。  
精度：0.01mm



## 6173

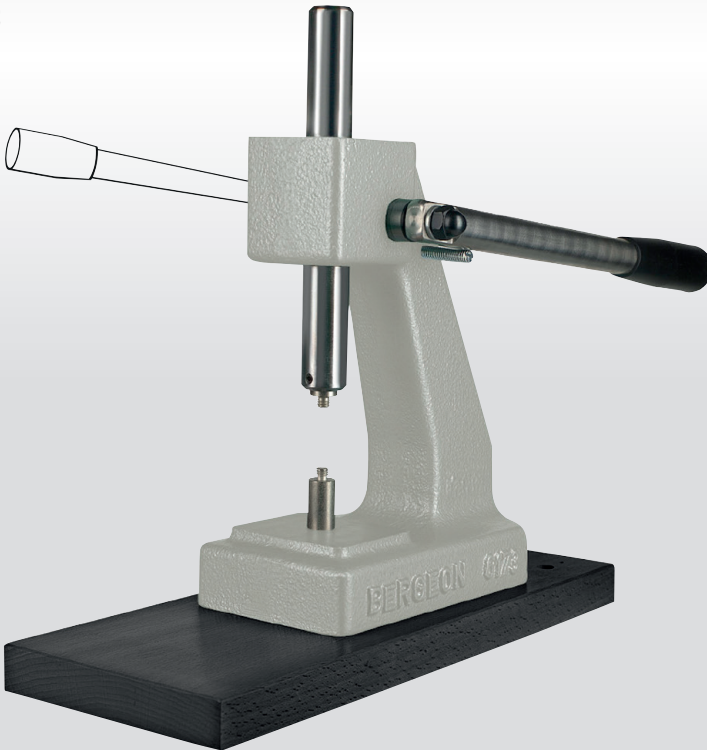

### Press for multiple uses

Very suitable for closing pressure back cases.  
Operable for right- and left-handed users.  
Working height max. 110 mm.  
Delivered with 2 supports for chucks with usable  
height of 3mm and 21mm.  
Optional: Micrometric stop.

### 多用途滚齿式冲压机

适用于按压式手表底盖。  
惯用右手或者左手的使用者均可使用。  
可用高度：110mm  
带有两个夹头支架，适用于3mm及21mm的夹头高度。  
可选配：微调器













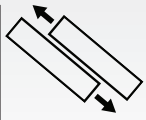









8820

swiss made



## Characteristics of the tweezers' tips

### 镊子尖端的不同特性

<b>Materials</b> 材料	 ESD 防静电	 Heat resistance 耐高温	 Chemical resistance 耐腐蚀性	 Mechanical resistance 耐磨损性	Color 颜色
<b>CFR</b> Carbon fiber 碳纤维	Conductible  导电性	 130°			
<b>SVR</b> Teflon 特氟隆	Conductible  导电性	 150°			
<b>CPR</b> Carbon Peek 合成碳料Peek	Dissipative  耗散性	 260°			
<b>DGR</b> Delrin Delrin料	Isolating  绝缘性	 85°			



Excellent

优



Good

良



Poor

差

**6571-CFR-...**

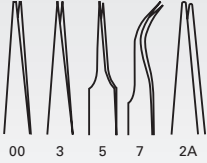

**CFR**



**Tweezers with carbon fiber tips**

**带碳纤维尖端的镊子**

**6571-SVR-...**

 **swiss made**

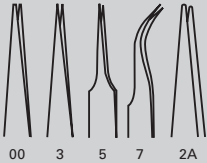

**SVR**



**Tweezers with tips in Teflon**

**带特氟隆(Teflon)涂层尖端的镊子**

**6571-CPR-...**

swiss made

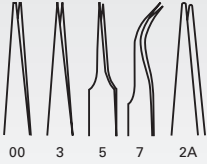

**CPR**



Tweezers with tips in synthetic carbon Peek

带合成碳料PEEK尖端的镊子

**6571-DGR-...**

swiss made

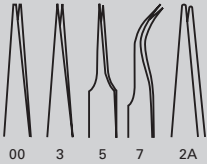

**DGR**

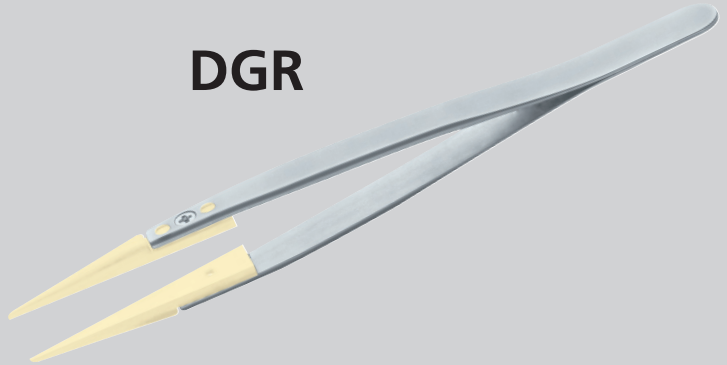

Tweezers with tips in white Delrin

带白色Delrin尖端的镊子



## 7572-ESD-...

swiss made

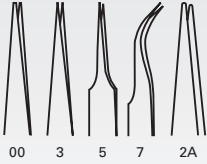

# ESD

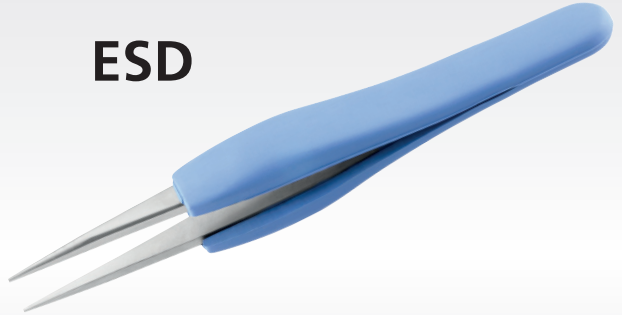

### ESD tweezers coated with nitrile rubber membrane

Grip coated with a vulcanized nitrile rubber membrane, very resistant. Dissipative ESD Safe.

### 防静电镊子

外包硫化丁腈胶膜，坚固耐用。防静电耗散。

## 7571-DC-...

swiss made

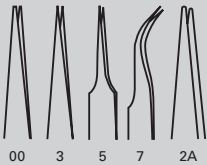

# DC

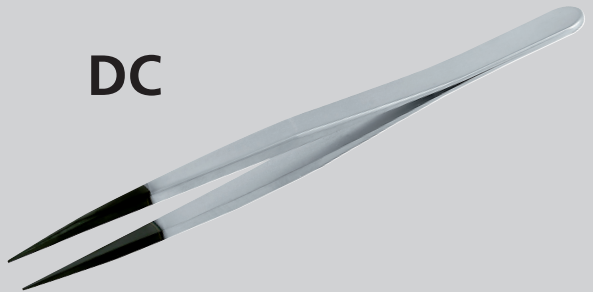

### Tweezers with hardened tips by diamond coating

Tips coated with a thin carbon layer, developing a crystalline structure similar to a natural diamond. Very high level of hardness: until 80 GPa.

### 尖端带钻石粉涂层的的镊子

尖端带有一层薄的碳元素涂层，该晶体结构类似真正的钻石。

非常高的硬度：直到80 GPa.

**6571-BUR-3**

🇨🇭 swiss made



**Tweezers with points in wood**

High density to handle the components.

**木制尖端的镊子**

高密度材质，用于拿取零件。

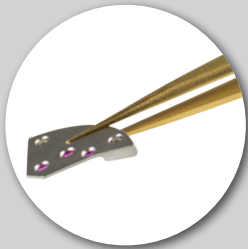

**7029-1AM**

🇨🇭 swiss made



**7029-2AM**

**Tweezers with Gold flash**

Brass, coated with a gold flash.  
The coating protects against oxidation and preserves the particular smell of the brass.

**黄铜镊子，镀金色**

黄铜材质，镀金色。  
电镀层可以保护镊子不被氧化以及阻隔黄铜的特殊气味。

Tweezers

的镊子

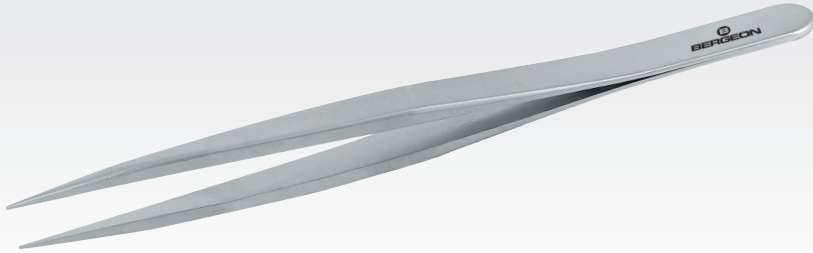

**B**JET

swiss made

**7024** ➤ 1/2/3/4/5/AA

Nonmagnetic steel, common finish.  
Suits for works with a minor precision needed.

防磁钢，普通抛光。  
适用于微小精度的作业。

**B**ci

swiss made

**7026** ➤ 0/00/1/2/3/3C/4/5/6/7/AA/F/S/SS

Nonmagnetic steel, acid-resistant, trimmed finish.  
Good resistance to corrosion.

防磁钢，抗酸性，精细抛光。  
抗腐蚀性能佳。

# BVOX

swiss made

**7027** ➤ 0/00/1/2/3/3C/4/5/6/7/7A/15A/AA/F/S/SS

Stainless steel, trimmed finish.  
Recommended for its hardness.

不锈钢，精细抛光。  
硬度佳。

# BXEL

swiss made

**7025** ➤ 0/1/2/3/3C/4/5/6/7/11/AA/SS

Nonmagnetic steel, acid-resistant, "high quality" alloy, trimmed finish.  
Very good resistance to corrosion, heat (450°), acids and 100% nonmagnetic.

防磁钢，抗酸性，"高品质"合金，精细抛光。  
下列性能极佳：抗腐蚀，耐高热(450°),抗酸性以及100%防磁。

# B★

swiss made

**7028** ➤ 0/1/2/3/3C/4/5/6/7/AA/F/S/SS

Superalloy (Ni-Cr-Mo), nonmagnetic, acid-resistant, trimmed finish. Until 6 times harder than "common" nonmagnetic steels, resistant to corrosion, heat (800°) and 100% nonmagnetic.

超合金（镍-钴-钼），  
抗酸性，精细抛光。是普通防磁钢硬度的6倍。抗腐蚀，耐高热(800°)以及100%防磁。

7865-2L



1450 x 650 x 930-1230 mm

### Watchmaker bench

Watchmaker bench, height adjustable by crank system. Robust bench top in beech. 2 cabinets with 5 drawers and a central drawer. Armrest in imitation leather and adjustable angles.

### 表匠工作台

表匠工作台，高度可手动调节。坚实榉木台面。2组各带有5个抽屉的储物柜以及一个中间抽屉。仿皮手靠，可调节角度。

# B I F L E X

SWISS MADE

7943



## Air/Vacuum for Bench

Complete Biflex system with counterweights and locking device. Including a precision blower and a vacuum stylus (one precision blower and two vacuum styluses for the TriFlex ref. 7943-TRI).

To enhance ergonomics, the pipes are adjustable, flexible and separable.

## 装于工作台的吹/吸尘套件

配以精密吹管与吸尘扫。  
柔性套管可作多方位移动以方便使用。  
附喉管锁紧，自动复位功能。



**8809-R45**

swiss made



**8809-RD**

**Vacuum stylus**

Flow adjustable by pusher,  
to be used with a vacuum pump or on the network.

**真空笔**

按钮式风速控制  
配合真空机或真空网络使用

**8809-B-2**



**8809-B-1**

*Very soft*  
非常柔软的



*Soft*  
柔软的

**8809-B-3**



*Coarse*  
粗糙的

**Brushes for vacuum stylus**

Synthetic bristles.

**真空笔毛刷**

合成材料鬃毛



7809-R45

swiss made



7809-RD

**Precise bellows**

Flow adjustable by pusher, to be used with a compressor or on the network.

**精密吹风管**

按钮式风速控制  
配合空压机或气动网络使用

**R-COMBI**

SWISS MADE

6100-230



Pressure  
压强

Vacuum  
真空



700 x 440 x 590 mm

**Combi-vacuum compressor  
with air dryer**

Vacuum: -0.8 bars. Pressure: 8 bars.  
Sound level: 40 dB. Flow: 50 L / min. Tank: 2x14 L.

**真空/空压两用机，附干燥系统**

最大真空度：-0.8大气压。最高压力：8大气压。  
最高噪音：40dB。最高气流量：50升/分钟。  
气缸尺寸：2x14升。

76835-4-120

swiss made

76835-4-230

**witschi**

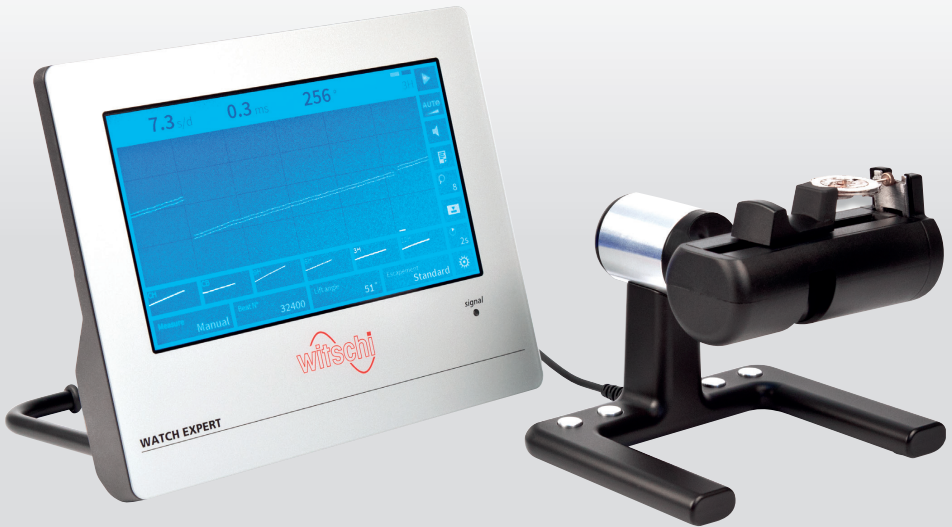

### New watch expert IV

The versatile and efficient test instrument for mechanical watches.

### 新一代WATCH EXPERT IV

专业及高效手表测试仪，适用于机械表。



Fine oil for fast geartrains  
快速齿轮用精油

	No	ml	Pce Fr.
	<b>1000-210-0005</b>	5	
	<b>1000-210-0020</b>	20	



Thick oil for slow geartrains  
慢速齿轮用稠油

	No	ml	Pce Fr.
	<b>1000-275-0005</b>	5	
	<b>1000-275-0020</b>	20	



Grease for escapement  
擒纵轮用油膏

	No	ml	Pce Fr.
	<b>1000-515-0005</b>	5	
	<b>1000-515-0020</b>	20	



Grease for mecanism  
机械组件用油膏

	No	ml	Pce Fr.
	<b>1000-620-0005</b>	5	
	<b>1000-620-0020</b>	20	



Grease for barrels  
发条轮用油膏

	No	ml	Pce Fr.
	<b>1000-735-0005</b>	5	
	<b>1000-735-0020</b>	20	



Fine oil for fast geartrains  
快速齿轮用精油

No	ml	Pce Fr.
<b>1000-E50-0020</b>	20	
<b>1000-E50-0100</b>	100	
<b>1000-E50-1000</b>	1000	

## 8500-KIT-MEC

swiss made

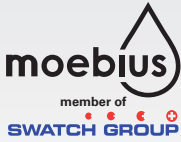

### MOEBIUS lubricant kit for mechanical watches

9104/5 ml	Train, frictions steel/steel
9415/2 ml	Escapement
9504/5 ml	Very high frictions
9010/2 ml	Train
9501/5 ml	Frictions hand setting

### MOEBIUS 润滑油套装，用于机械表

9104/5ml,	过轮，钢制摩擦部件
9415/2ml,	擒纵系统
9504/5ml,	高速摩擦部件
9010/2ml,	过轮
9501/5ml,	时间设置的摩擦部分

## 8500-KIT-QUA

swiss made



### MOEBIUS lubricant kit for quartz watches

- 9501-SC/5 ml Frictions hand setting
- 9104-SC/2 ml Micromotor
- 8302/5 ml Grease for mechanism
- 9014/2 ml Train
- 8212-SC/5 ml Natural soft grease for aluminium, weak braking

### MOEBIUS 润滑油套装，用于石英表

- 9501-SC/5ml 时间设置的摩擦部分
- 9104-SC/2ml 微型马达
- 8302/5ml 用于机械部分的油膏
- 9014/2ml 过轮
- 8212-SC/5ml 天然软膏，用于铝制部件，弱制动。

7284-...

Nano silver yarn wefts  
纳米级银线的方格图案。

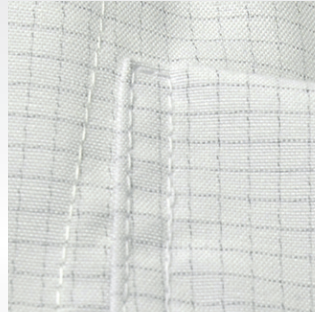

S - M - L - XL



### Antistatic coat for watchmaker nano silver yarn

Three pockets, double collar, pressure buttons, adjustable wrists with pressure buttons.  
Mixed fabrics: 63% polyester, 35% cotton and 2% nano silver yarn.  
Very light and comfortable, white plaid color with nano silver yarn wefts.  
Antibacterial.

### 表匠用防静电外衣，带有纳米级银线

3个口袋，双层衣领，按压式纽扣，手腕位置可用按钮调节。  
混纺布料：63%聚酯纤维，35%棉以及2%的纳米级银线。  
非常轻便及舒适。白色底色上带有纳米级银线的方格图案。  
防菌。

**2208**

330 x 330 mm

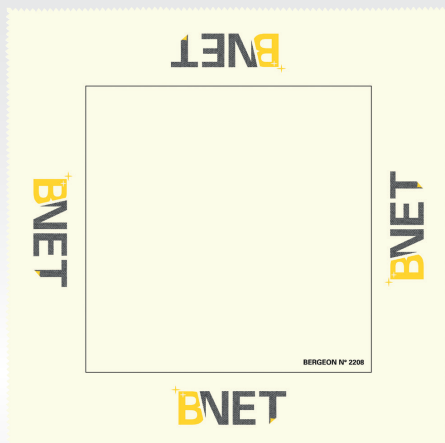

**B-Net cloth**

250 g/m2, 70% polyester, 30% polyamide.  
Washable to 40° C.

**B-NET抹布**

250g/m2, 70%聚酯纤维, 30%聚酰胺。可40°C水温  
以下清洗。

**7854-20**

300 x 300 mm

 20 x

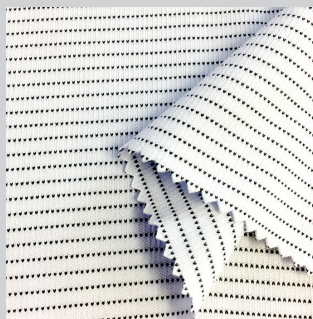

**White antistatic microfiber fabric  
with silver yarn**

240 g/m2, 80% polyester, 20% polyamide.

**白色防静电微纤布, 带银线**

240g/m2, 80%聚酯纤维, 20%聚酰胺。



7861



S - M - L - XL

### Gloves in microfibres

Highly resistant, non-impregnated. Very useful in shop to clean, to polish and to operate all kinds of glasses, metal watches and bracelets as well precious, semi-precious metals and precious stones. For dry use or with a cleaning product. Washable at 40°C.

### 微纤手套

耐用，非浸渍。非常适合店铺用于清洁，擦拭各类玻璃，金属手表及表带。也可用于贵金属，宝石及半宝石。可加或不加清洗液。可水洗，温度40°C。



2290

10 x

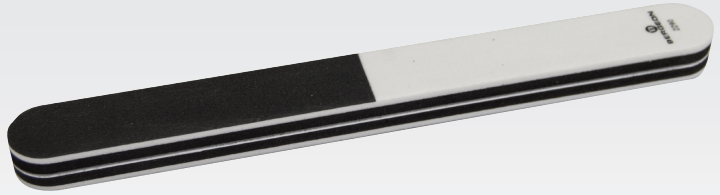

EBAUCHE - 粗磨

POLISH - 精磨

BERGEON  
2290

FINISH - 抛光



### Buff to polish

With 3 different abrasives allowing to buff bracelets and watch cases.

### 打磨条

有三种不同粗糙度，可用于打磨抛光表带以及表壳。

1283-A

swiss made

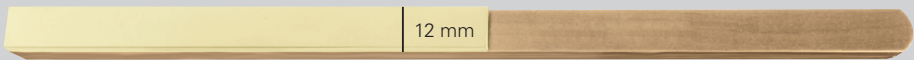

1283-D

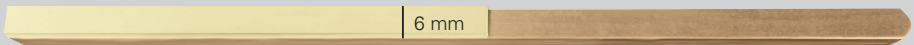

Wash leather buff

麂皮打磨棒

6886-AS-...-144



M - L - XL



**Thimbles**

Pack of 144 antistatic rubber thimbles without powder.

**手指套**

一包144pcs防静电橡胶手指套，无粉剂。

6886-SP-...-144



M - L - XL



**Thimbles**

Pack of 144 rubber thimbles without powder.

**手指套**

一包144pcs橡胶手指套，无粉剂。

5840-...-144



M - L - XL



### Thimbles

Pack of 144 rubber thimbles lightly powdered.

### 手指套

一包144pcs橡胶手指套，带轻微粉剂。

7872

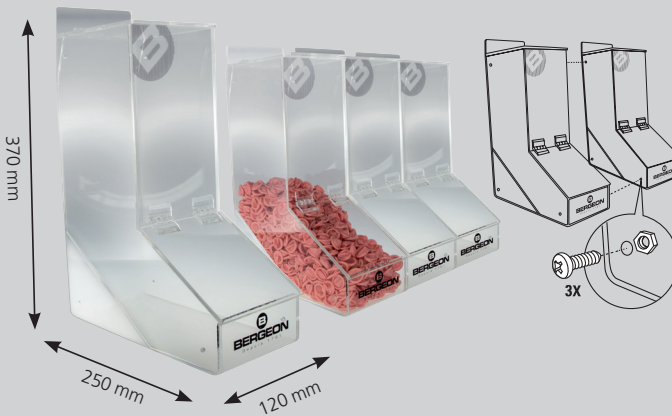

Thimbles dispenser acrylic glass

亚克力盒指套盛载器



Find all our products online  
在线查找我司产品

[www.bergeon.ch](http://www.bergeon.ch)



Bergeon SA

Tools and equipment for watchmakers, jewellers, precision engineering

Bergeon Hong Kong Office

香港，九龍，

長沙灣道 928 ~ 930號，  
時代中心 201室

Rm. 201, Times Tower,

928 ~ 930, Cheung Sha Wan Rd.,  
Kowloon, Hong Kong

Tel. +852 2658 0700

Fax +852 2658 0711

[www.bergeon.ch](http://www.bergeon.ch)

[info@bergeon.ch](mailto:info@bergeon.ch)